

Hydronix

Digital Moisture Measurement Sensors
for Bulk Solids and Liquids

Measuring Moisture and Brix



GRAIN : FEED : NUTS : OILS : GRANULES : LIQUIDS

Hydronix Moisture Sensors

Digital microwave moisture sensors for bulk solids

Hydronix offers a range of digital microwave sensors for use in the processing of bulk solids or liquid materials. Our range offers a choice of installation and temperature options enabling a sensor to be positioned in many locations where moisture, Brix or the concentration of liquid solutions needs to be measured.

Our unique digital measurement technique offers extreme precision over a wide moisture range. This technique also enables the user to select from a choice of measurement modes to ensure optimum performance in different materials and applications.

Hydro-Mix XT

For mixers and conveyors, this sensor is flush mounted and is easily installed in the floor of a mixer or the side of a screw conveyor.



Hydro-Mix HT

A high temperature sensor designed for drying, conveying and mixing systems with a continuous process temperature range up to 120°C.



Hydro-Probe XT

The Hydro-Probe XT is positioned in or underneath a bin / silo or hopper or above a belt conveyor in the flow of material.



Hydro-Probe Orbiter

This sensor can be installed in or underneath a bin / silo or hopper or above a belt conveyor with a material temperature range up to 100°C

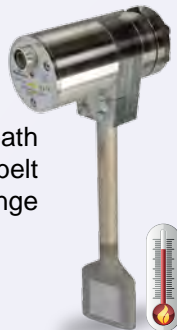

Hydro-Probe SE

A sensor capable of measuring moisture or Brix in liquids. Designed to operate at high temperatures in a pressurised process.



Features

- Choice of measurement modes for best results in different materials.
- High temperature sensor options.
- Fast response to changing conditions with 25 measurements per second.
- Consistent performance with no need for recalibration except for use with different materials.
- Install into new or existing systems.
- Range of installation options to suit all systems.
- Not affected by dust or colour.
- Easy to install and maintain.
- Built to withstand harsh environments.
- Temperature stable.
- Worldwide service and support.

Display and Control Options

Hydronix has a range of display and control options



Installation Options

Hydronix sensors can be mounted in many different locations throughout the process provided that there is a consistent flow of material across the ceramic faceplate. Some typical locations are indicated below.

Storage Bins / Silos / Hoppers

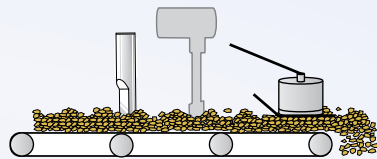
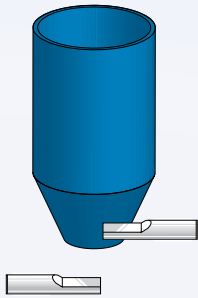

En-Masse Conveyor

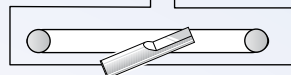

Conveying Systems

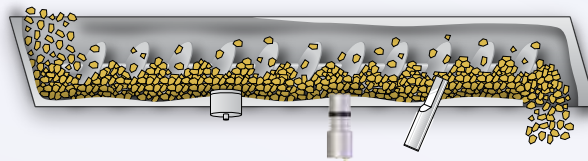

Ducting Systems

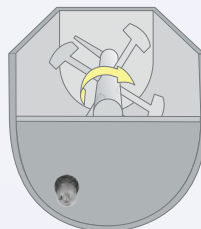
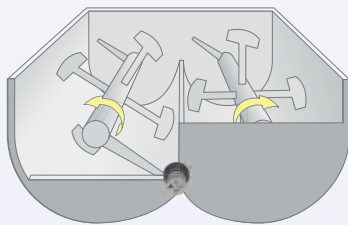
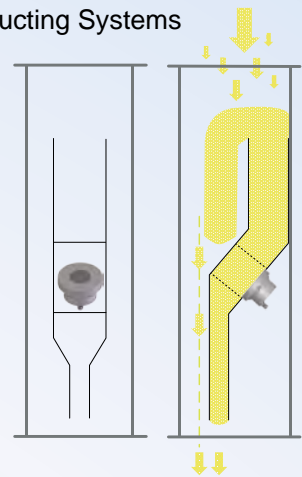

Mixing Systems

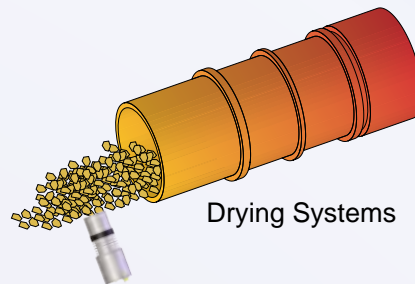

Drying Systems

Typical Applications:

Hydronix sensors can be used across many applications that process organic materials. Typical examples include: Coffee Beans, Oils, Biological Waste, Seeds, Rice, Nuts, Animal Feed, Wood Pellets and many others.



Nuts

Measure moisture in many varieties of nuts and kernels during processing.



Coffee / Seeds / Pulses

Moisture can be measured in green coffee beans, seeds, beans and pulses.



Reducing Liquids

The concentration of a liquid in an evaporation process can be measured.



Oils

Moisture can be measured in many oils including olive and recycled engine oil.

Grain and Cereals

Control moisture during drying or the addition of mould inhibitors



Animal Feed

Control moisture during mixing and/or the pelletising process



Sensor Installation and Integration

Construction

Body: Stainless Steel.
Faceplate: Ceramic.

Fixing

Hydronix supplies a range of fixing accessories for mounting the sensors in a variety of different applications.

Operating Temperature

0-60°C.
High temperature options available up to 120°C.

Measurement Range

Moisture: 0-100%, material dependant
Depth: Approx 75-100mm, material dependant.
The Hydro-Probe SE will also measure between 50°Bx to 100°Bx.

Refresh Rate

25 times per second.

Analogue Outputs

Two configurable 4-20mA or 0-20mA current loop source available for moisture and temperature. May also be converted to 0-10V DC.

Digital Inputs/Output

Two configurable digital signals available for averaging and alarm functions.

Digital (Serial) Communication

Opto-Isolated RS485 2-wire port. RS232 converter, Ethernet and USB interfaces available.

Programming details to access sensor values and parameters are available on request.

Extension Cable

Six twisted pairs, 22AWG, 0.35mm² conductors. Screen braid with 65% minimum coverage plus aluminium/polyester foil. Maximum cable run of 100m.

Power Supply

+15V to +30V DC, 4W.

Integration Options

A combination of up to 16 Sensors can be connected on the RS485 network

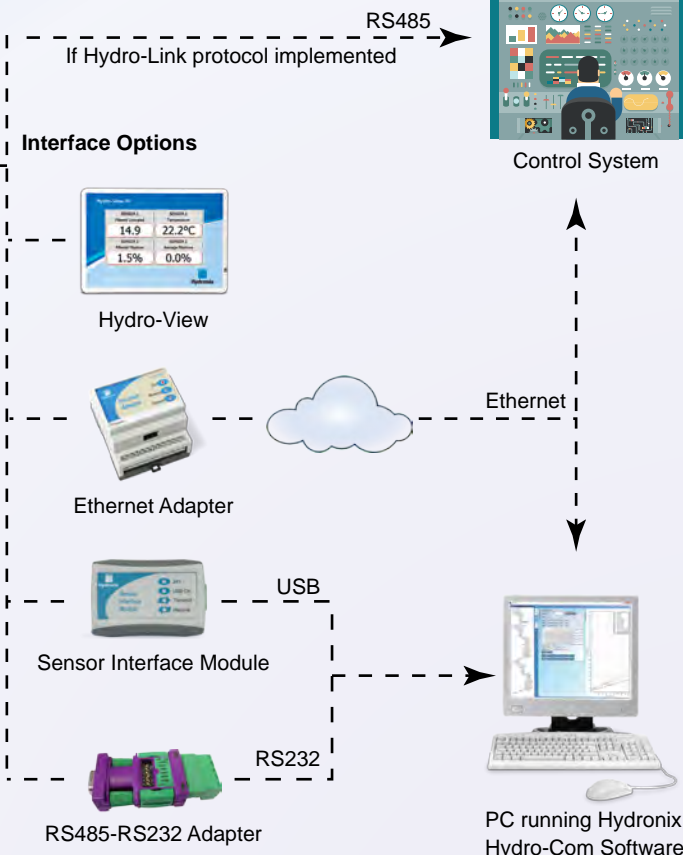
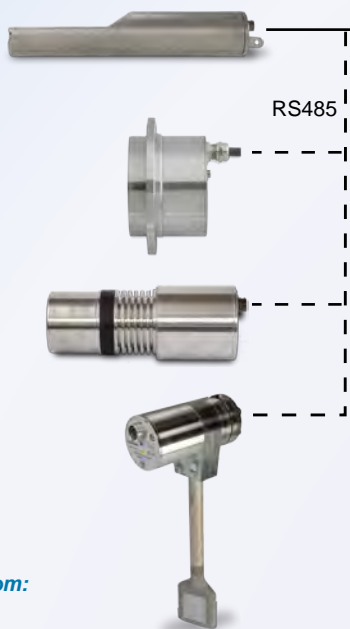

Hydronix

Head Office - United Kingdom:

Tel: +44 (0)1483 468900
Fax: +44 (0)1483 468919

Email: enquiries@hydronix.com

Central Europe & Southern Africa:

Tel: + 49 2563 4858

France:

Tel: + 33 652 04 89 04

Americas, Spain & Portugal:

Tel: 888-887-4884 (toll free)
or +1 231 439 5000

www.hydronix.com